

# BIRAIL FRAMELESS SLIDING DOORS - 2 PANELS

REFERENCE

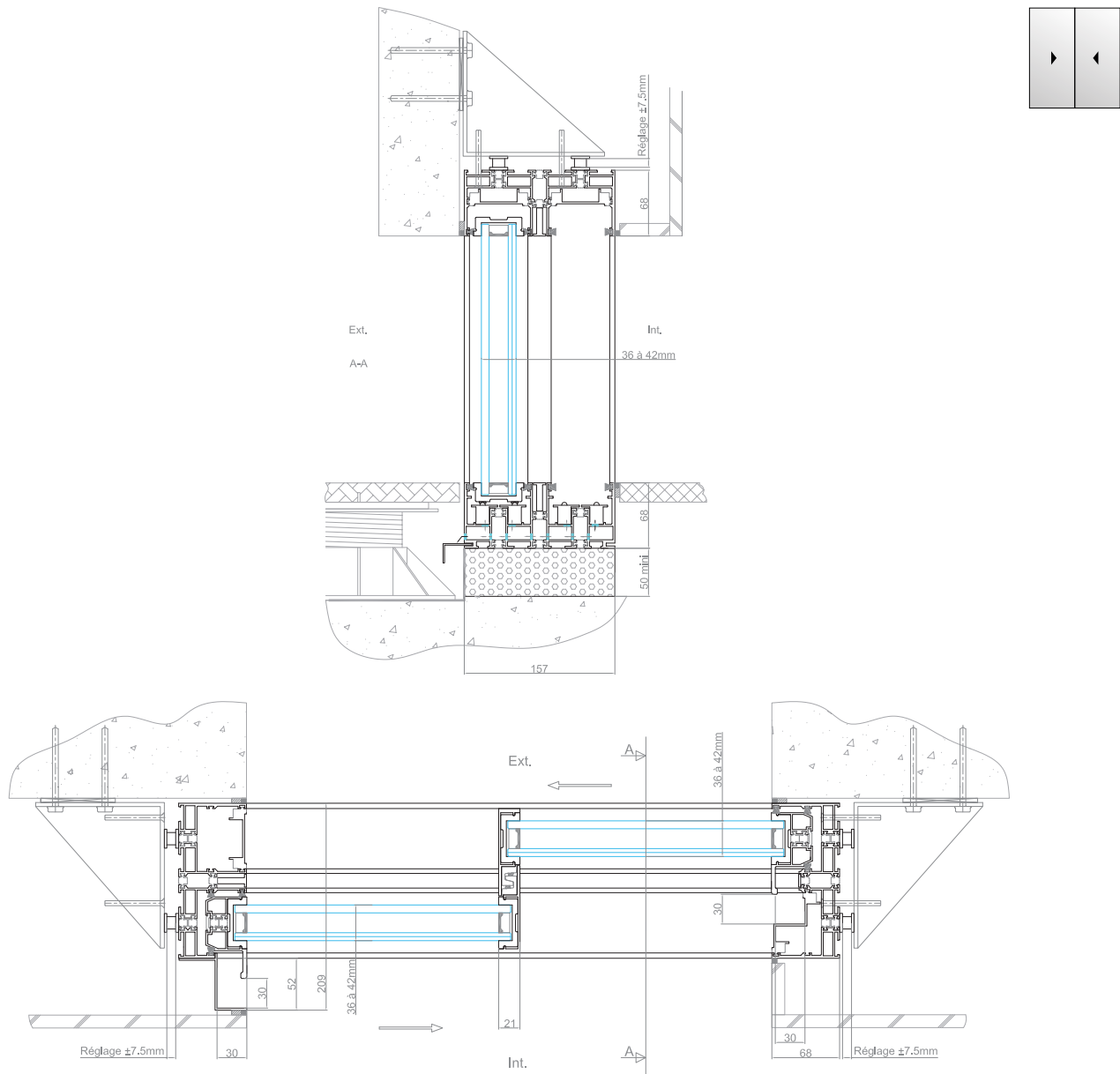

Inside mounted



# BIRAIL FRAMELESS SLIDING DOORS - 2 PANELS

Outside mounted

REFERENCE

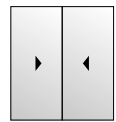
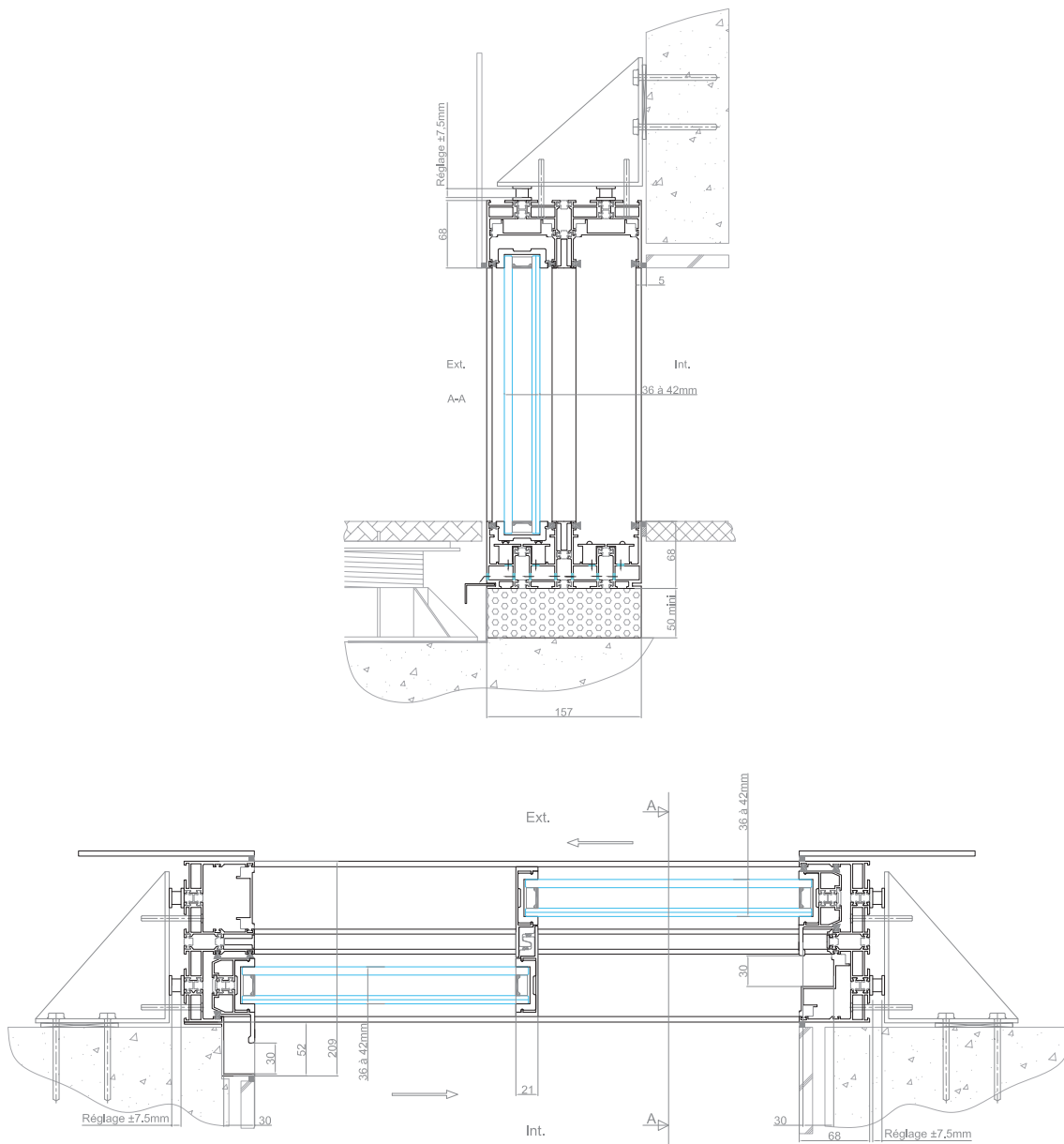

# BIRAIL FRAMELESS SLIDING DOORS - 2 PANELS

REFERENCE



Fitting within the reveal mounted

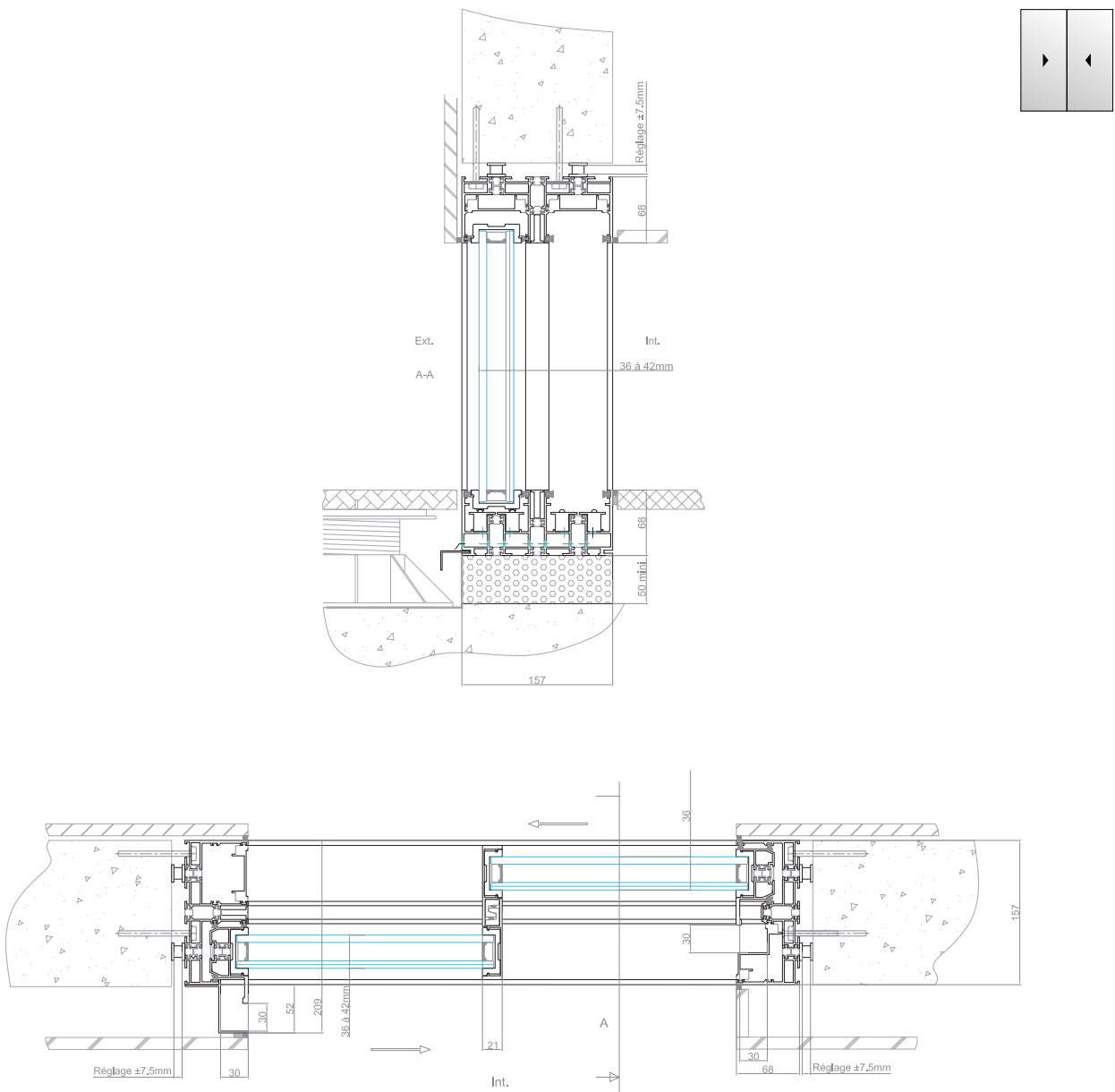

# MONORAIL FRAMELESS HIDDEN SLIDING DOOR(S) 1 PANEL

REFERENCE

G 1 1

Inside mounted

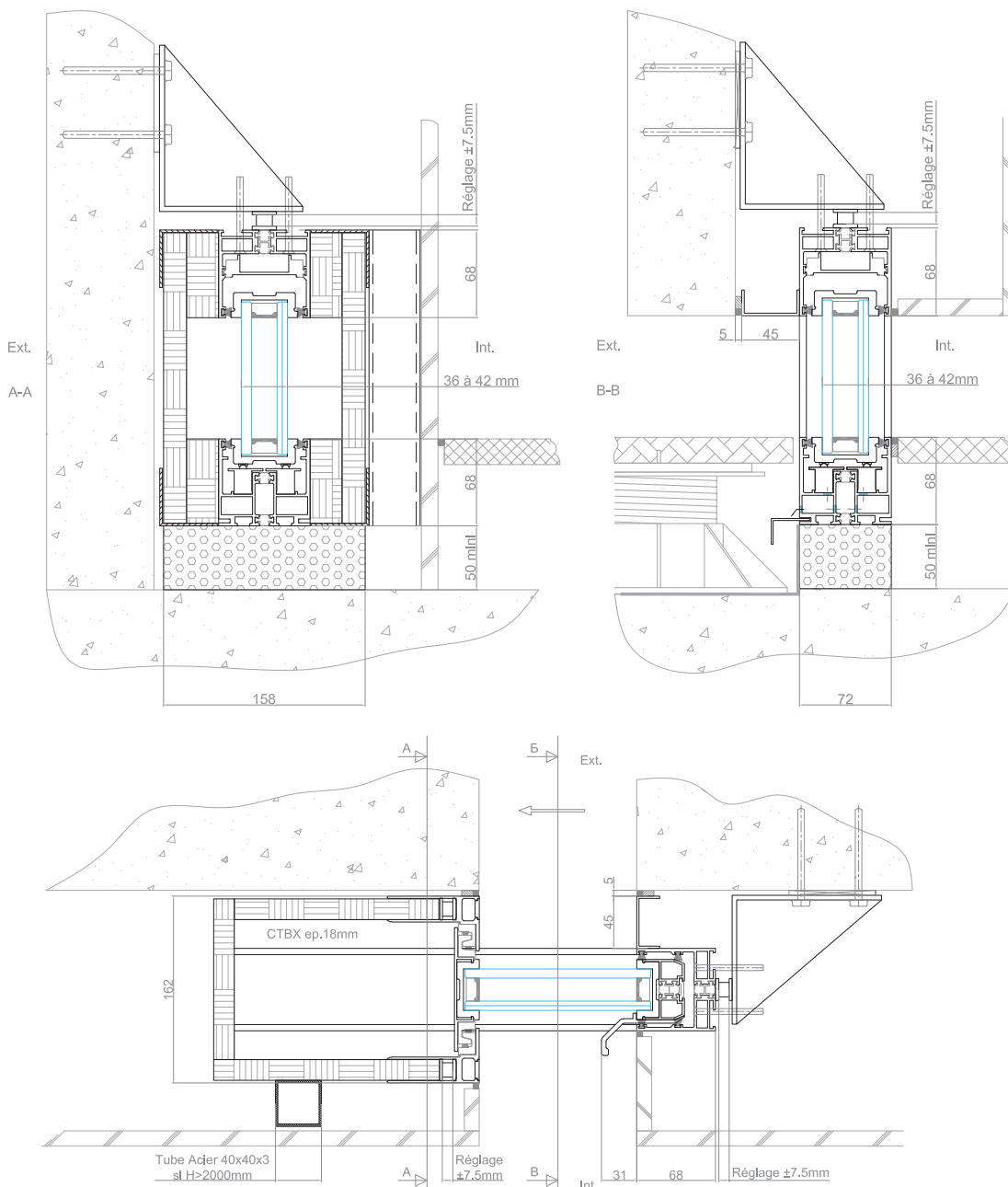

# MONORAIL FRAMELESS HIDDEN SLIDING DOOR(S) 1 PANEL

REFERENCE

G 1 1

Outside mounted

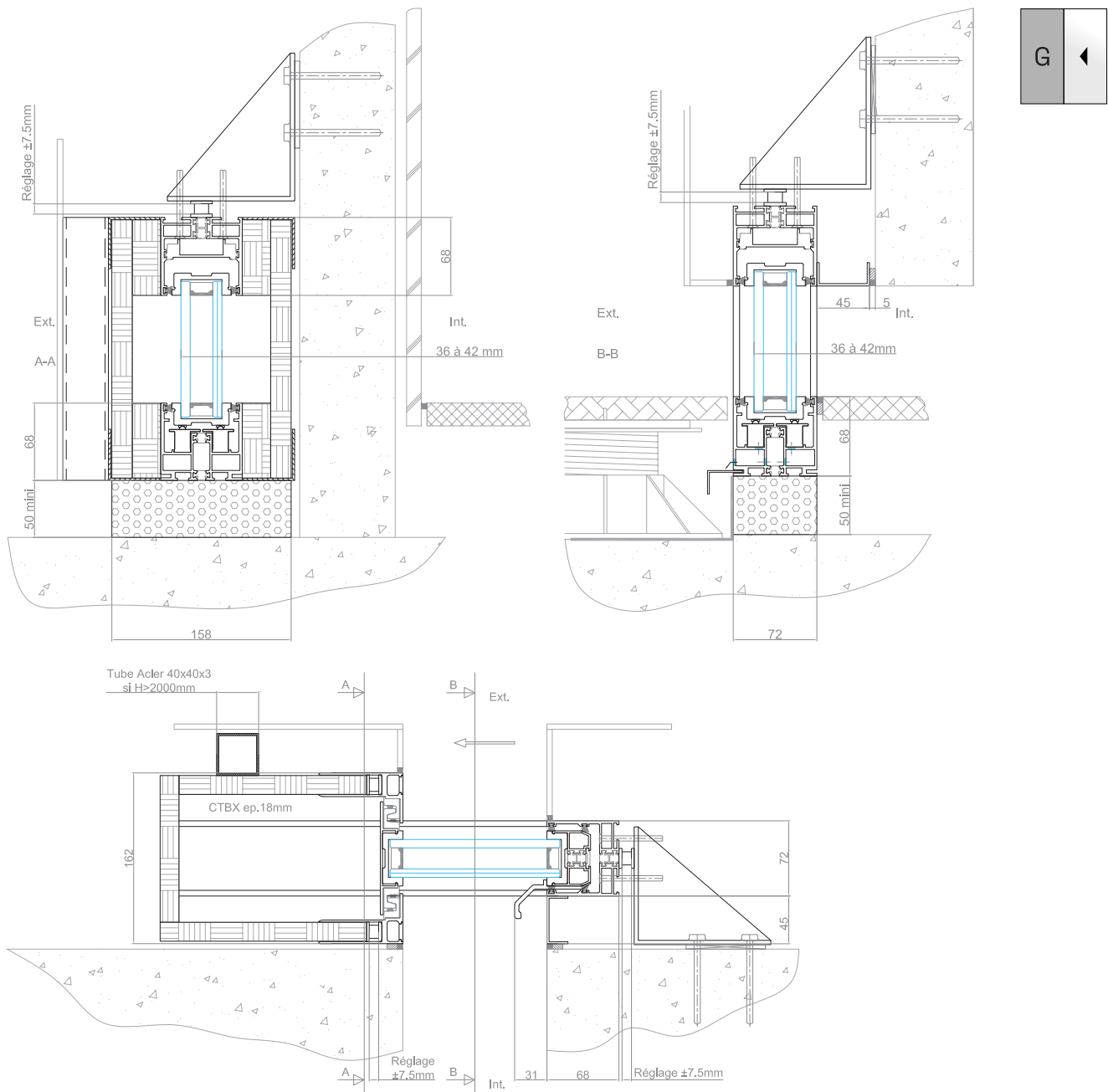

# MONORAIL FRAMELESS HIDDEN SLIDING DOOR(S) 1 PANEL

REFERENCE

G 1 1

Fitting within the reveal mounted

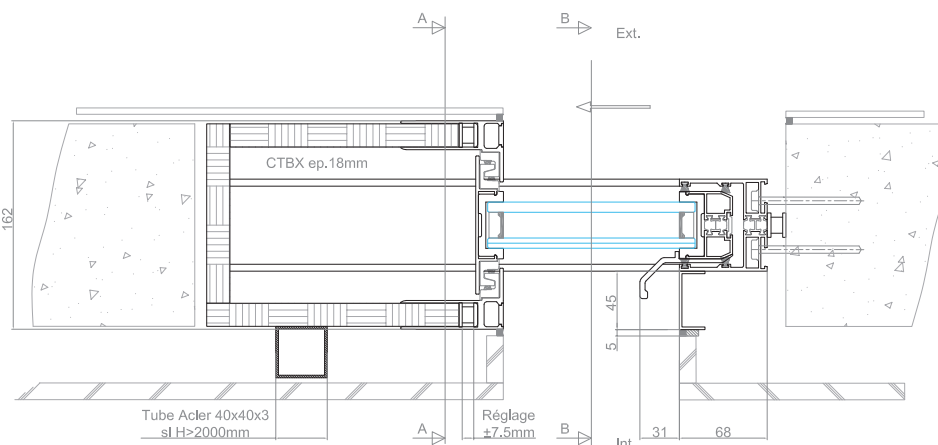
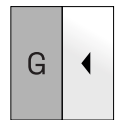
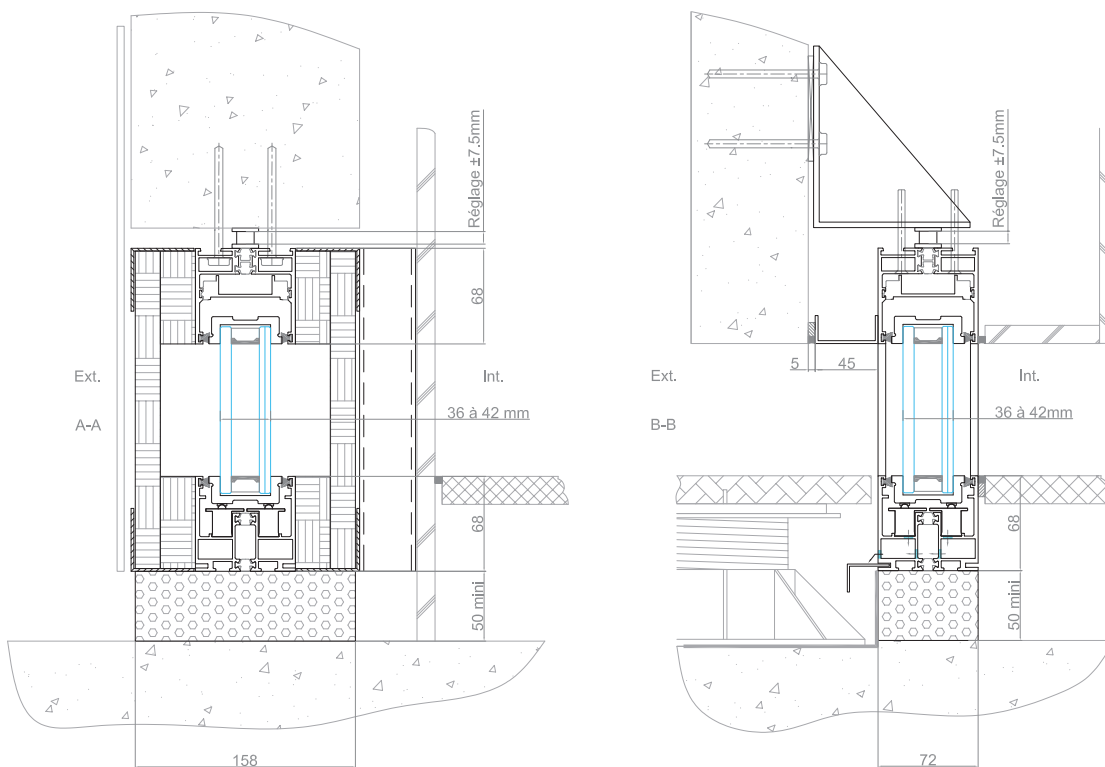

## OPTIONS

Joins

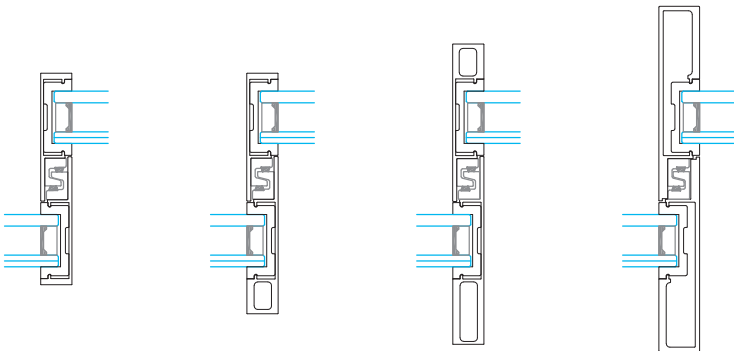

Reversed  
joins

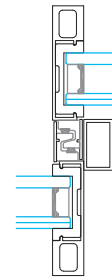

Curtain wall

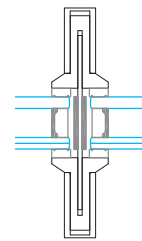

Handles  
frames

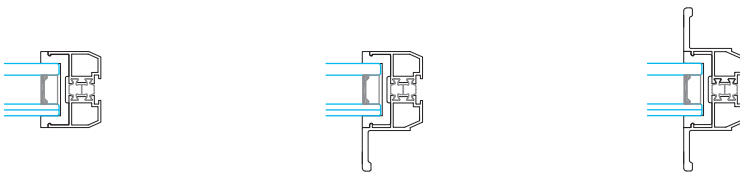

Center  
opening

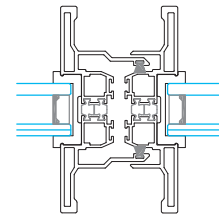

Angle frame

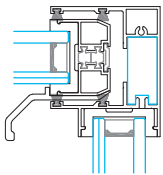

Channels

